

TECHNICAL DATA

Three Phase Electric Motors - Cast Iron Frame
 PE30 355L2 4 IE3
 280 kW / 380 Cv
 1490 RPM

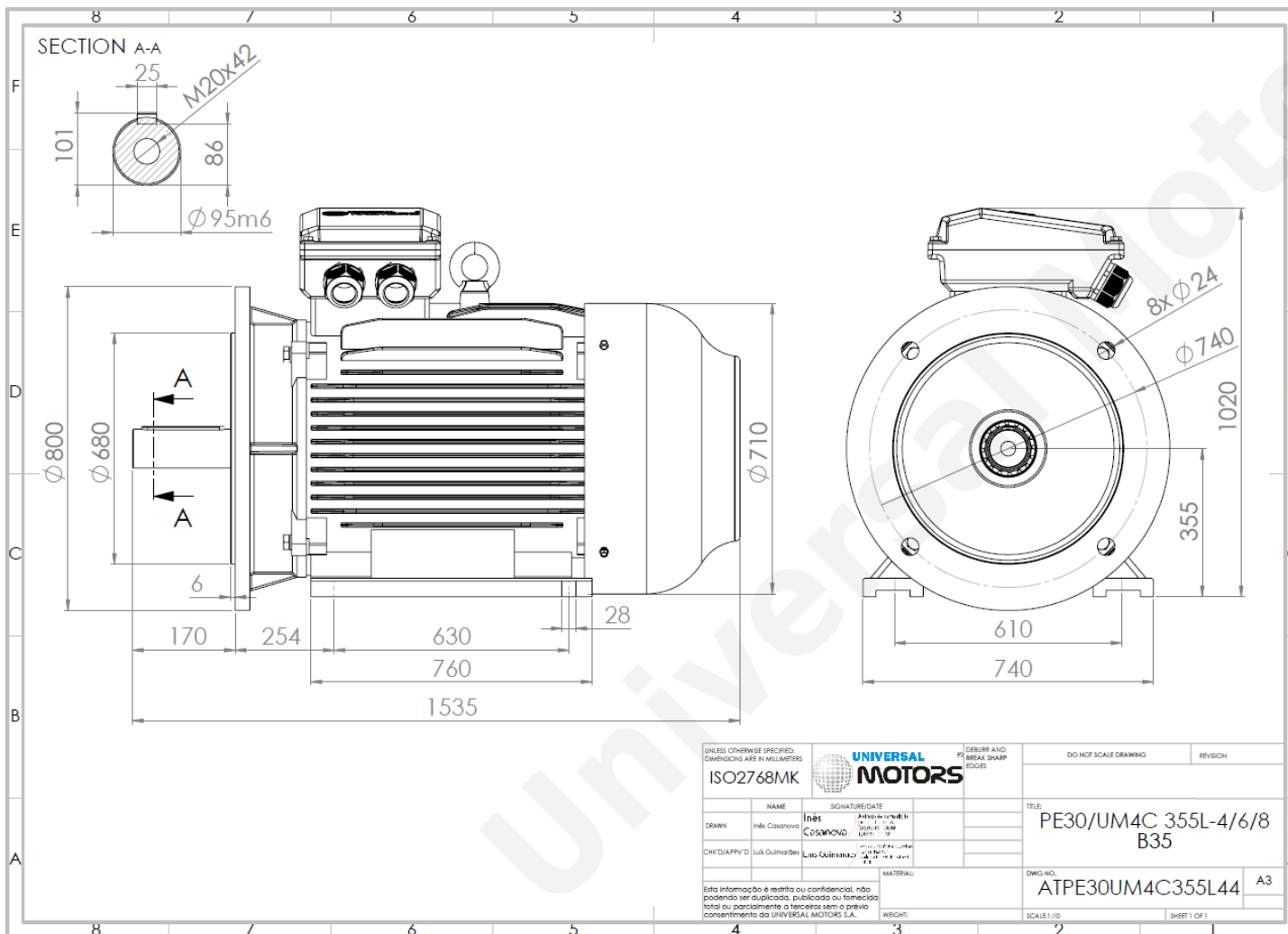

Motor type:	PE30 355L2 4 IE3
Output:	280 kW / 380 Cv
Speed (min ⁻¹):	1490 RPM
Frequency:	50 Hz
Voltage:	690 V
Current:	269 A
Power factor (Cos Ø):	0.90
Poles:	4
Insulation class:	F
Temperature rise Class:	B
Efficiency 50%:	95.0 %
Efficiency 75%:	95.9 %
Efficiency 100%:	96.0 %
Torque:	1795 N.m
Tstarting/Tnominal:	2.0
Istarting/Inominal:	7.1
Tmaximum/Tnominal:	2.2
Noise:	95 Db(A)
Weight:	1710 Kg
Bearing DE:	NU 322
Bearing NDE:	6322 C3

Regime - S1

Altitude - 1000m

Environment Temperature - 40°C

CONTACTS:

UNIVERSAL MOTORS Tel: +351 252 299 080
 Rua de São Brás,745 Fax: +351 252 299 089
 4480-782 VILA DO CONDE Mail: geral@universalmotors.pt

* References applied only in the UK